

GMP C2 LASHER PARTS IDENTIFICATION GUIDE

for model series 71422

Effective March 15, 2015

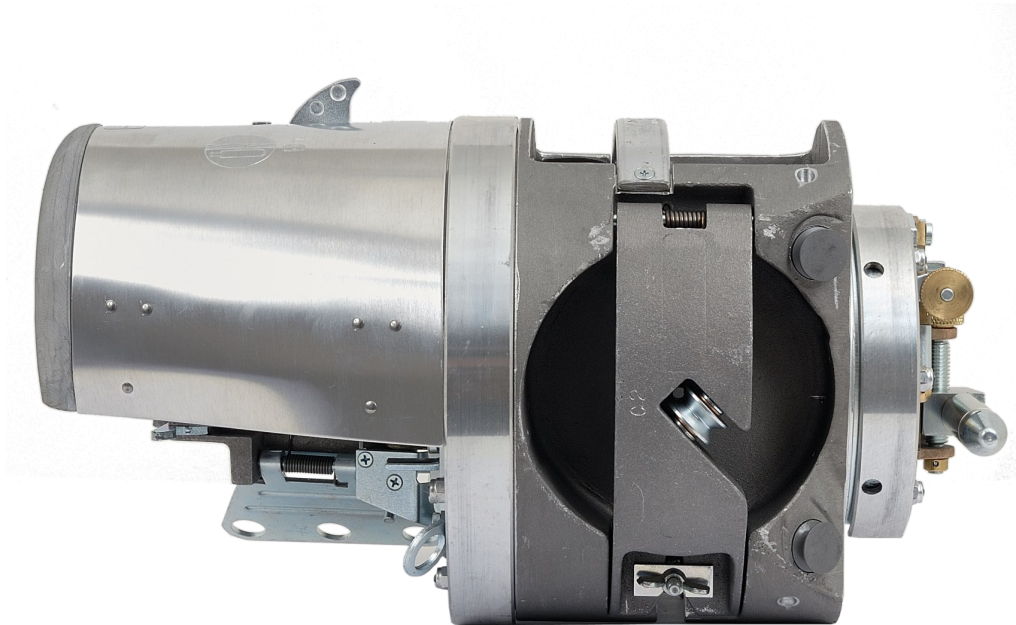

CRAFTWORKTOOLS™
Exclusive Distributer for GMP Lasher Parts



C2 Cable Lasher Parts Identification Guide
Contact: GMP 3111 Old Lincoln Hwy Trevose, PA 19053 USA
Tel: (215) 357-5500 Fax: (215) 357-6216
www.GMPtools.com

Note: Some Images may appear larger than they are for clarity purposes.

*C2 parts and price list_CWT_update 051515.pub
AK 7/8/2015*

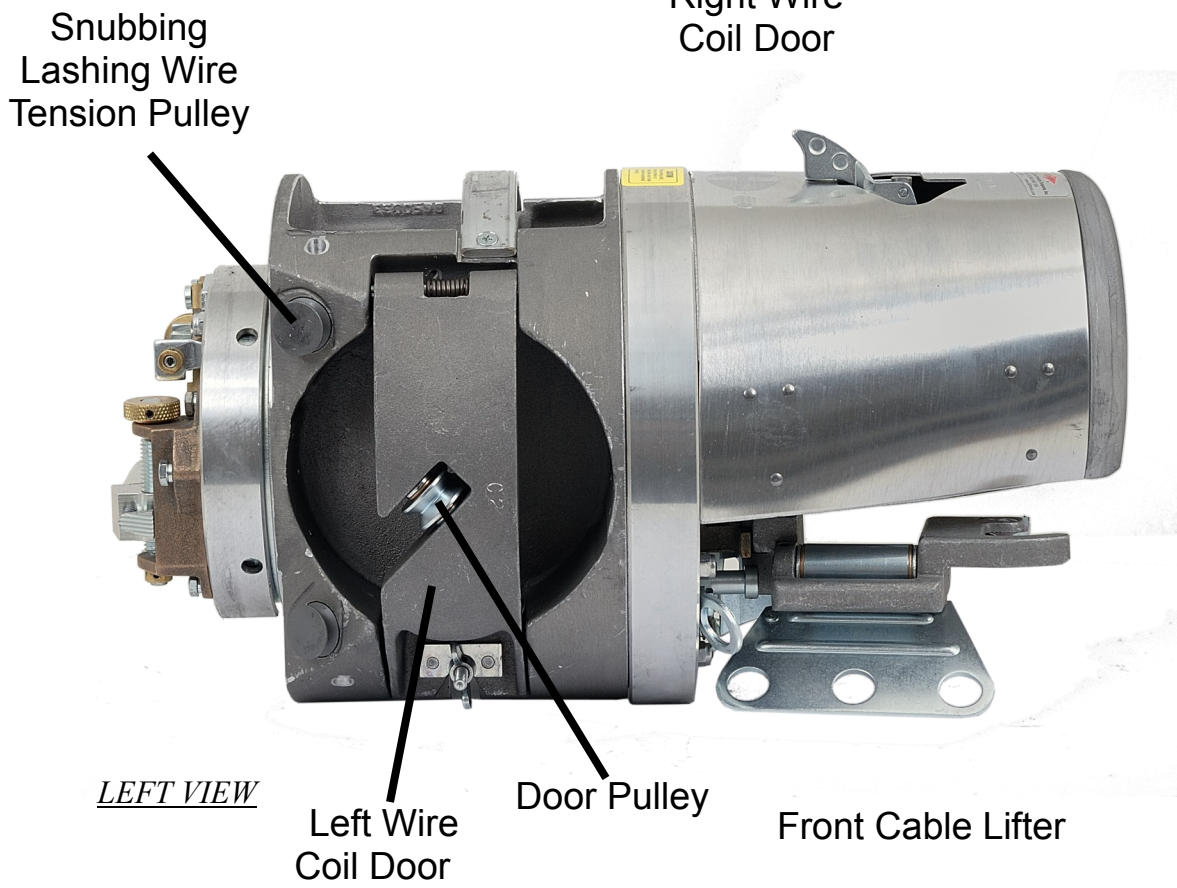
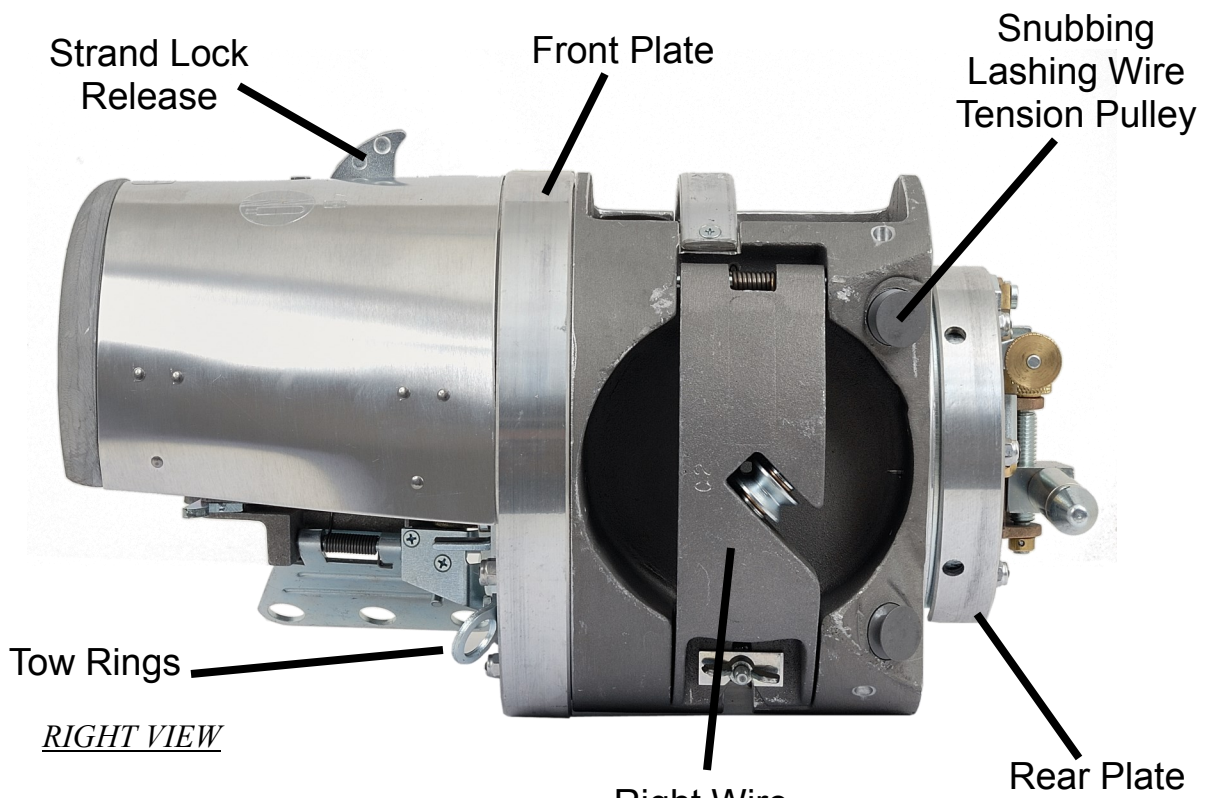

C2 Cable Lasher Parts Identification Guide

Contact: GMP 3111 Old Lincoln Hwy Trevose, PA 19053 USA
 Tel: (215) 357-5500 Fax: (215) 357-6216
 www.GMPtools.com

Note: Some Images may appear larger than they are for clarity purposes.

C2 parts and price list_CWT_update 051515.pub
 AK 7/8/2015

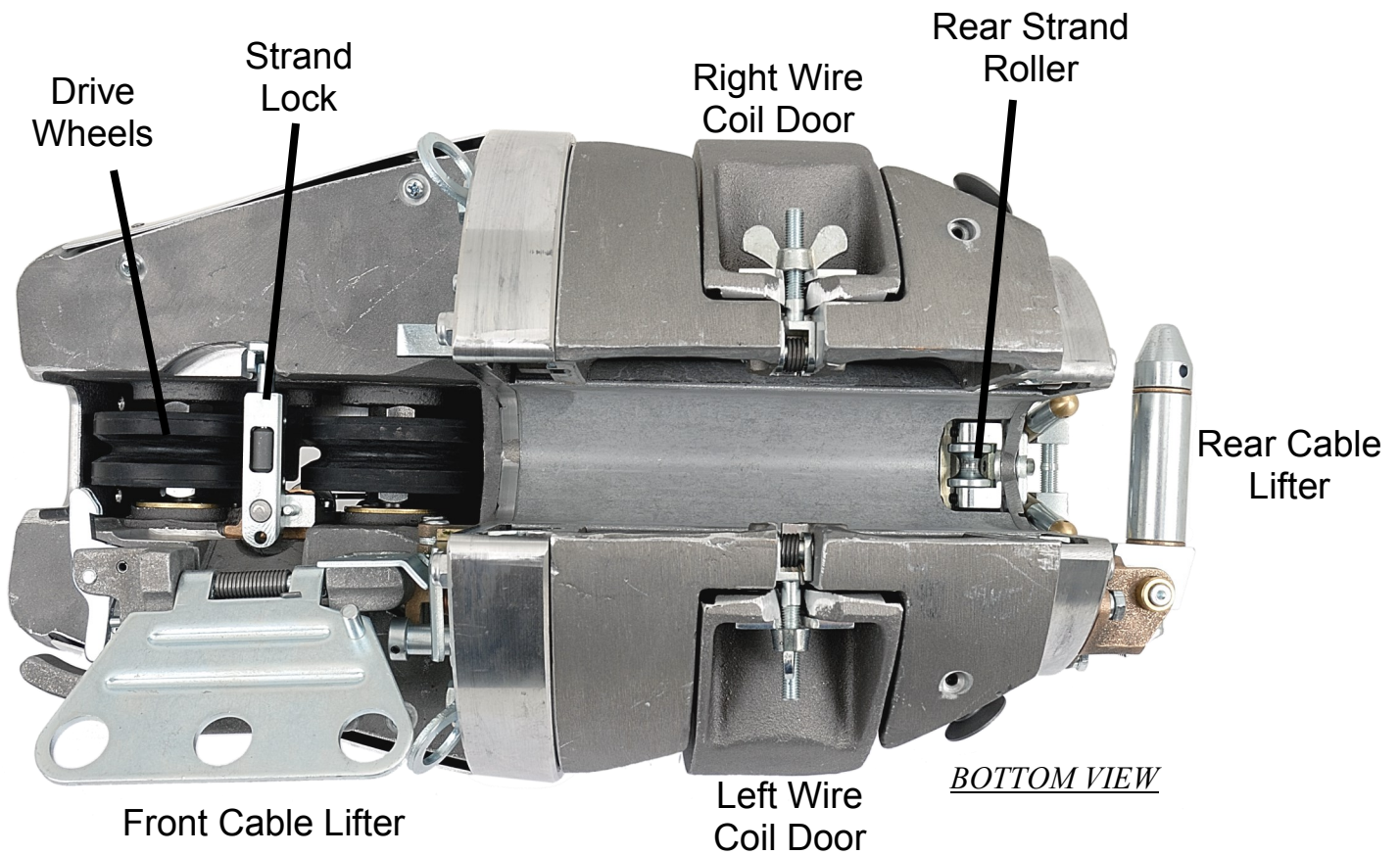
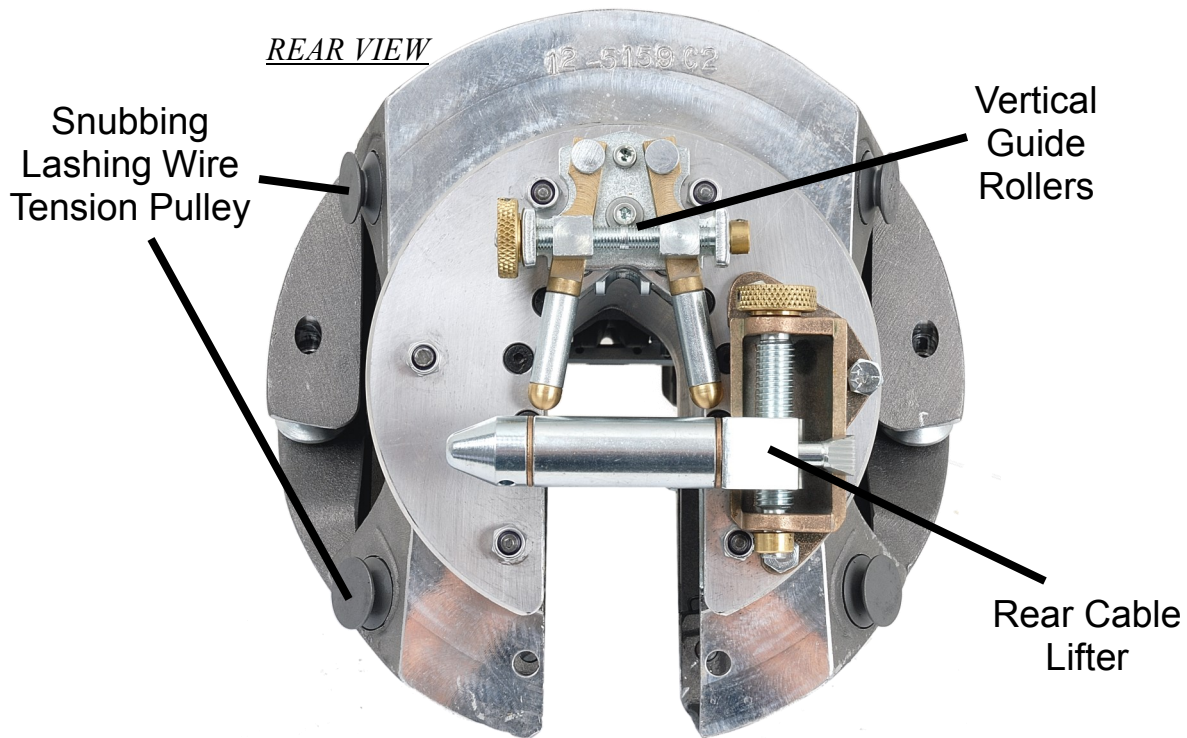

C2 Cable Lasher Parts Identification Guide

Contact: GMP 3111 Old Lincoln Hwy Trevose, PA 19053 USA

Tel: (215) 357-5500 Fax: (215) 357-6216

www.GMPtools.com

Note: Some Images may appear larger than they are for clarity purposes.

C2 parts and price list_CWT_update 051515.pub
AK 7/8/2015

PARTS LOCATOR

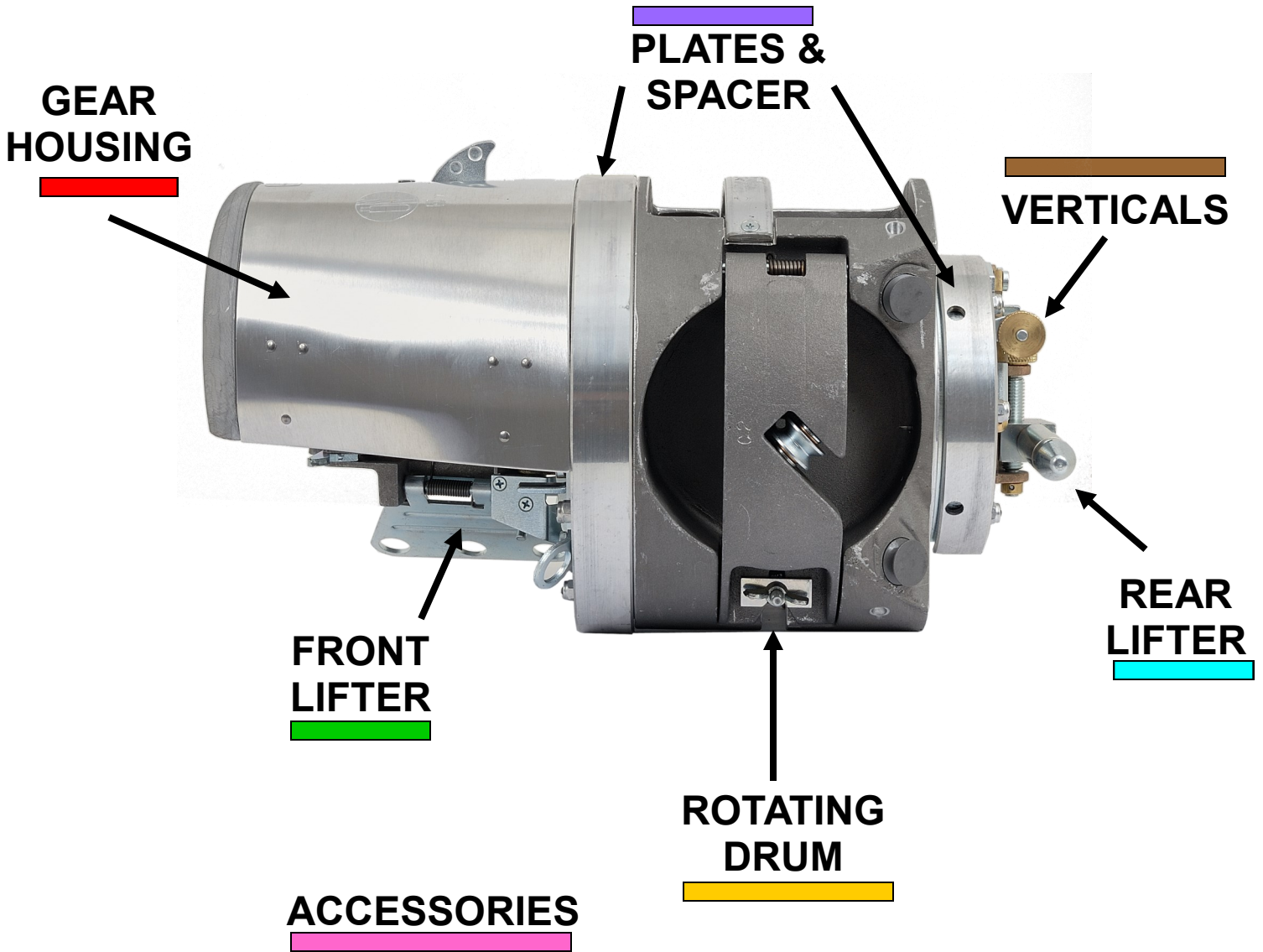



C2 LASHER GEAR HOUSING

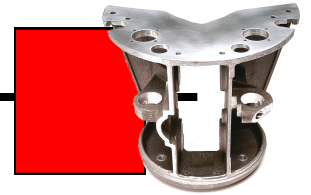

GEAR HOUSING - C2
p/n 27670

REAR WHEEL STRAND
DRIVE - J2/C2
p/n 07558



FRONT WHEEL KIT -
J2/C2
p/n 33356

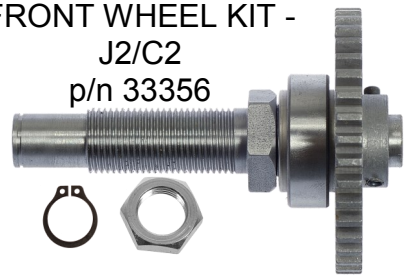

L.H. PINION ASSY - C2
p/n 27697



R.H. PINION ASSY - C2
p/n 15011

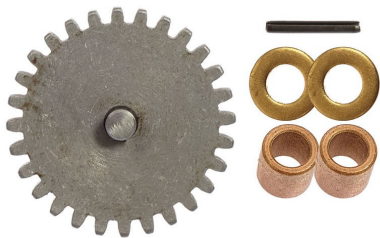

IDLER GEAR AND SHAFT
KIT - J2/C2 - p/n 33274



GEAR HOUSING BEARING
KIT - J2/C2 - p/n 33358



GEAR HOUSING COVER
C2 - p/n 33385



BEARING RETAINING KIT - J2/C2
p/n 33272



STRAND WHEEL KIT
- J2/C2
p/n 33359



TAPERED PLUG KIT
- J2/C2
p/n 33353

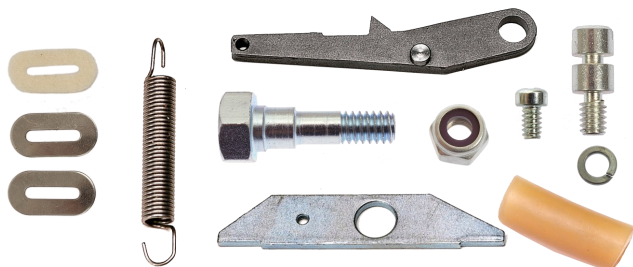

RATCHET KIT - C2
p/n 33387

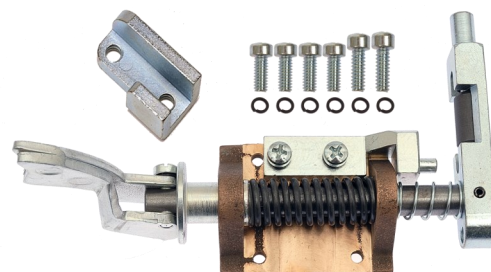

TENSION ROLLER KIT - C2
p/n 33388



C2 Cable Lasher Parts Identification Guide

Contact: GMP 3111 Old Lincoln Hwy Trevose, PA 19053 USA
Tel: (215) 357-5500 Fax: (215) 357-6216
www.GMPtools.com

Note: Some Images may appear larger than they are for clarity purposes.

C2 parts and price list_CWT_update 051515.pub
AK 7/8/2015



C2 LASHER ROTATING DRUM

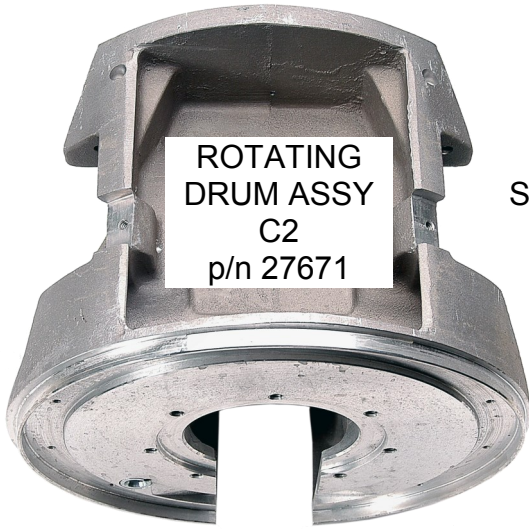

ROTATING DRUM ASSY
C2
p/n 27671



SNUBBING PULLEY KIT -
J2/C2 - p/n 33362



DOOR PULLEY KIT -
J2/C2 - p/n 33361

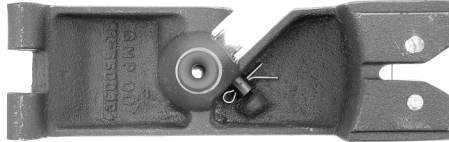

L.H. DOOR ASSY - C2
p/n 03403

NOTE: CASTING # ON DOOR IS B650039

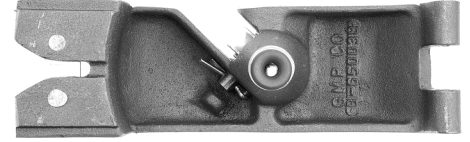

R.H. DOOR ASSY - C2
p/n 03404

NOTE: CASTING # ON DOOR IS B650038



HANDLE KIT - C2
p/n 33416

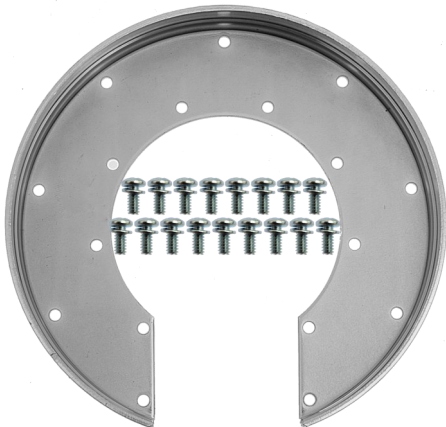

SMALL RING KIT - C2
p/n 33389

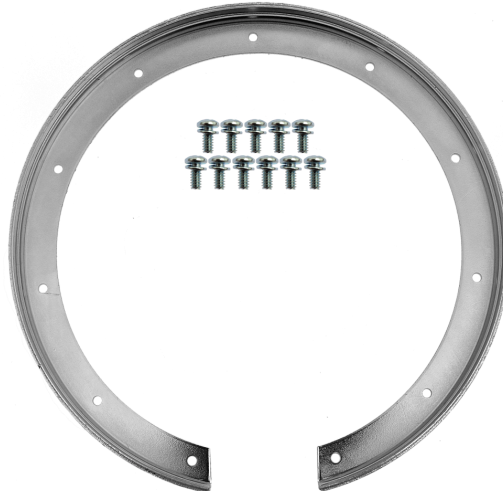

LARGE RING KIT - C2
p/n 33390

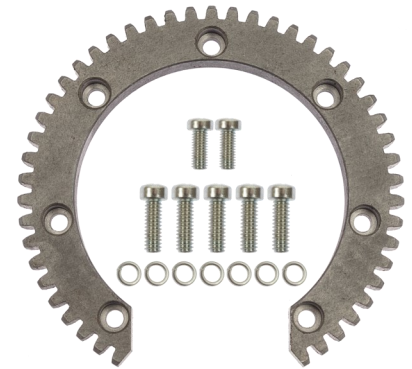

RING GEAR KIT - C2
p/n 33391

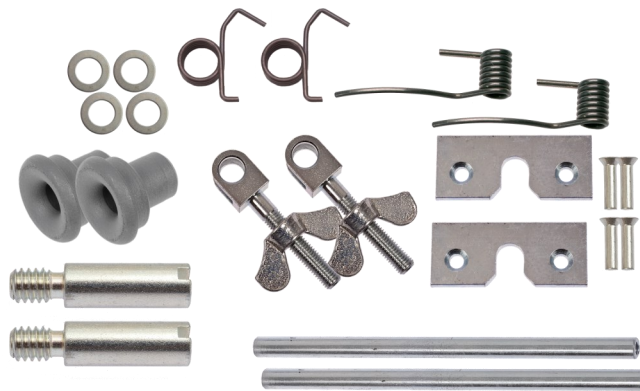

DOOR ACCESSORY KIT - C2
p/n 33407



C2 Cable Lasher Parts Identification Guide

Contact: GMP 3111 Old Lincoln Hwy Trevoze, PA 19053 USA
Tel: (215) 357-5500 Fax: (215) 357-6216
www.GMPtools.com

Note: Some Images may appear larger than they are for clarity purposes.

C2 parts and price list_CWT_update 051515.pub
AK 7/8/2015



C2 LASHER SPACER AND PLATES

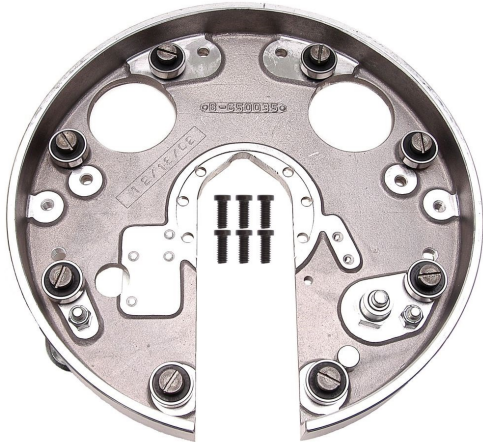
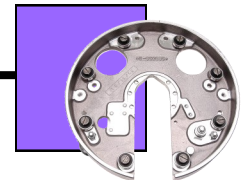

FRONT PLATE ASSY. - C2
p/n 27688

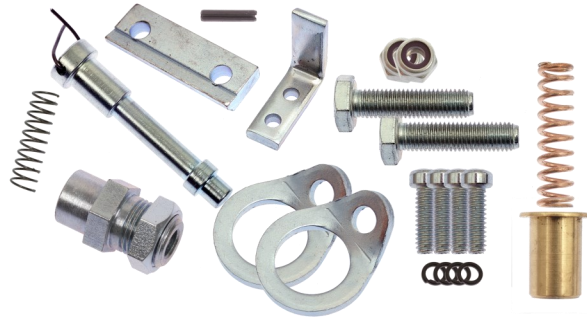

FRONT PLATE ACCESSORY KIT - C2
p/n 33394



FRONT BEARING KIT - C2
p/n 33396

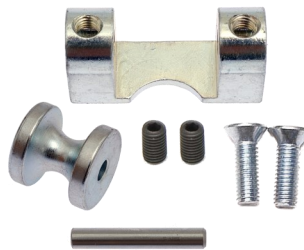

ROLLER STRAND KIT - C2
p/n 33393

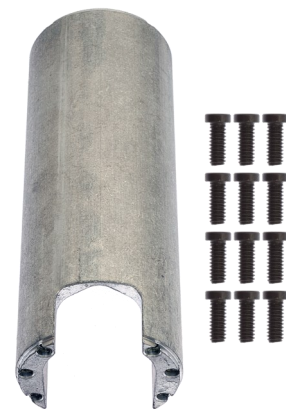

SPACER KIT - C2
p/n 33392

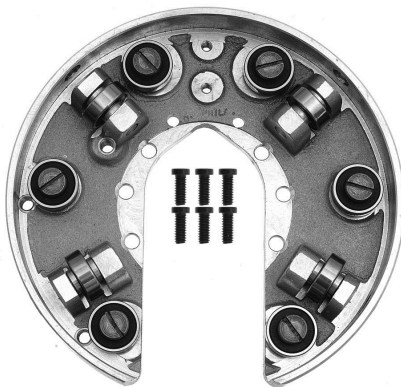

REAR PLATE ASSEMBLY - C2
p/n 27689



REAR BEARING KIT - C2
p/n 33395



C2 Cable Lasher Parts Identification Guide

Contact: GMP 3111 Old Lincoln Hwy Trevose, PA 19053 USA
Tel: (215) 357-5500 Fax: (215) 357-6216
www.GMPtools.com

Note: Some Images may appear larger than they are for clarity purposes.

C2 parts and price list_CWT_update 051515.pub
AK 7/8/2015



C2 LASHER FRONT LIFTER

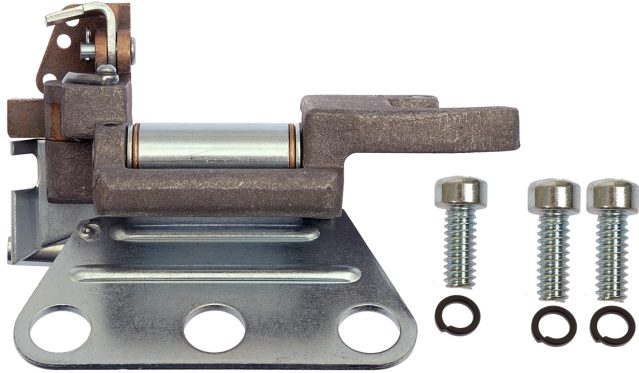
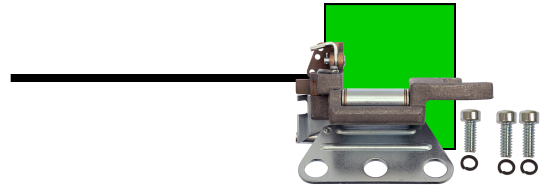

FRONT LIFTER ASSY COMPLETE. - C2
p/n 33397

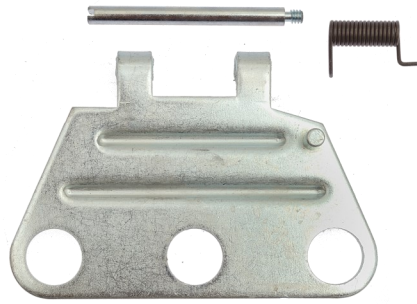

TOW PLATE KIT - C2
p/n 33399

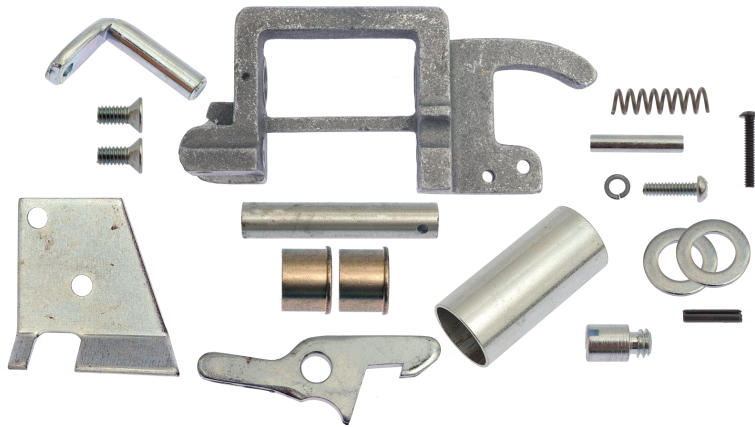

MOUNTING KIT - C2
p/n 33398

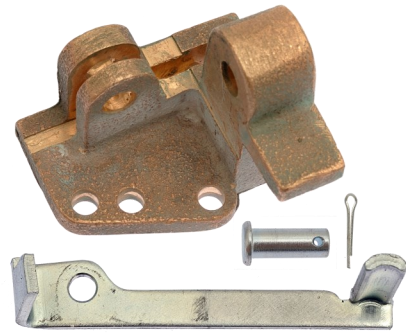

HINGE BRACKET KIT - C2
p/n 33400



C2 Cable Lasher Parts Identification Guide

Contact: GMP 3111 Old Lincoln Hwy Trevose, PA 19053 USA
Tel: (215) 357-5500 Fax: (215) 357-6216
www.GMPtools.com

Note: Some Images may appear larger than they are for clarity purposes.

C2 parts and price list_CWT_update 051515.pub
AK 7/8/2015



C2 LASHER REAR LIFTER

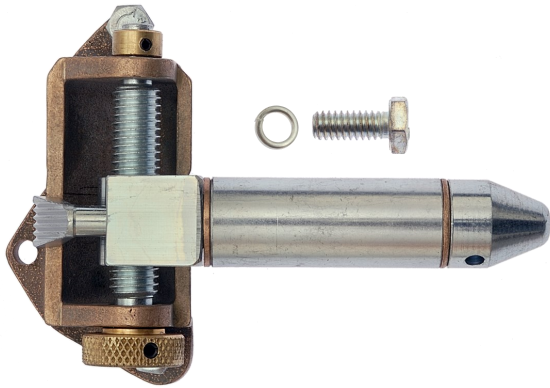
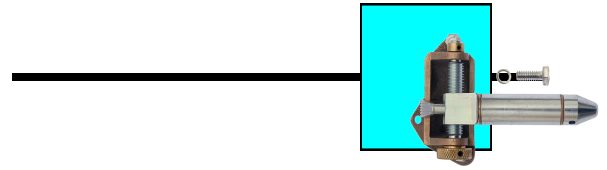

REAR LIFTER KIT COMPLETE - C2
p/n 33401

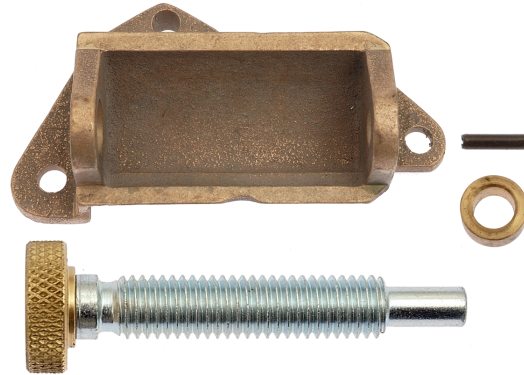

REAR BRACKET HINGE. - C2
p/n 33402

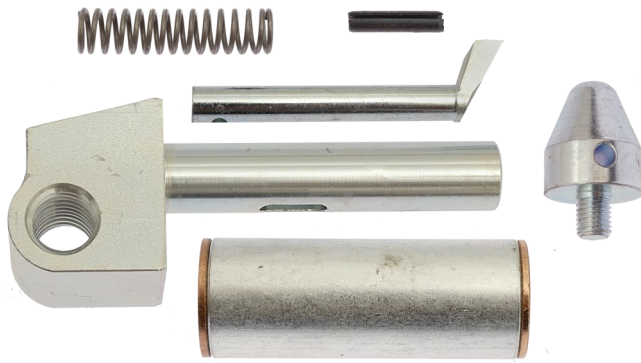

SHAFT KIT - C2
p/n 33403



C2 Cable Lasher Parts Identification Guide

Contact: GMP 3111 Old Lincoln Hwy Trevose, PA 19053 USA
Tel: (215) 357-5500 Fax: (215) 357-6216
www.GMPtools.com

Note: Some Images may appear larger than they are for clarity purposes.

C2 parts and price list_CWT_update 051515.pub
AK 7/8/2015



C2 LASHER VERTICAL GUIDE ROLLERS

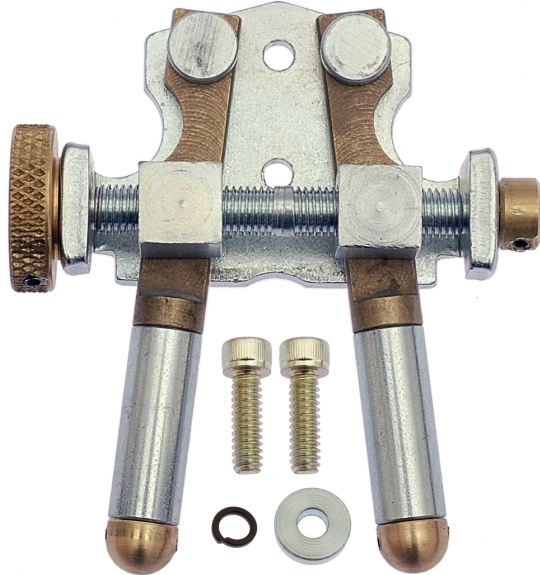
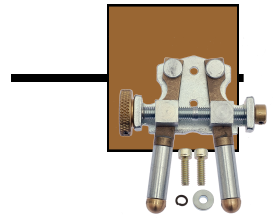

VERTICAL ROLLER KIT COMPLETE - C2
p/n 33404



ROLLER ASSY. - C2
p/n 33405

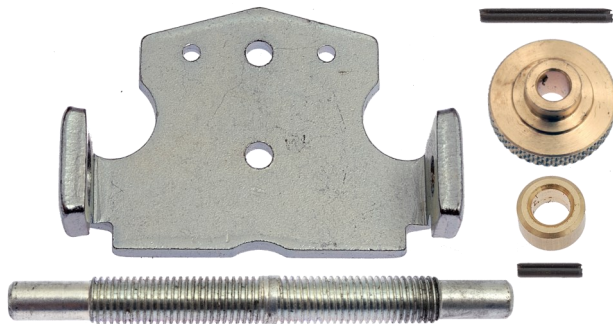

MOUNTING KIT - C2
p/n 33406



C2 Cable Lasher Parts Identification Guide

Contact: GMP 3111 Old Lincoln Hwy Trevose, PA 19053 USA
Tel: (215) 357-5500 Fax: (215) 357-6216
www.GMPtools.com

Note: Some Images may appear larger than they are for clarity purposes.

C2 parts and price list_CWT_update 051515.pub
AK 7/8/2015



C2 LASHER MISCELLANEOUS

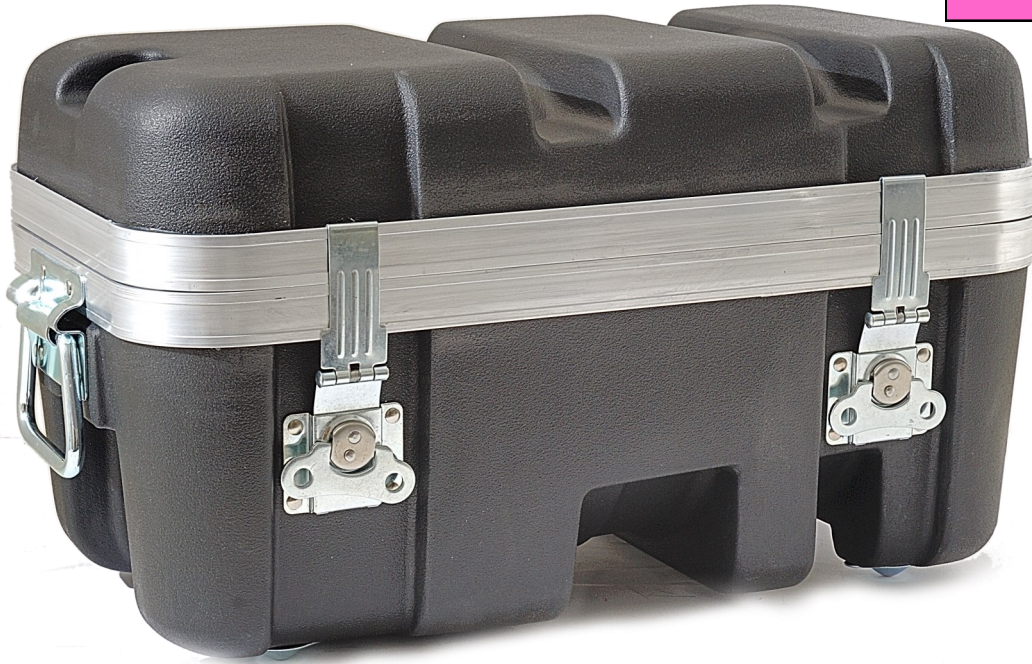
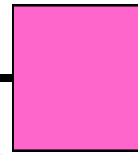

STORAGE AND TRANSPORT CHEST - C2
p/n 07143



Bridle Rope Assembly
P/N 03165



Towing Lanyard 35' Long
P/N 70190



C2 Cable Lasher Parts Identification Guide

Contact: GMP 3111 Old Lincoln Hwy Trevose, PA 19053 USA
Tel: (215) 357-5500 Fax: (215) 357-6216
www.GMPtools.com

Note: Some Images may appear larger than they are for clarity purposes.

*C2 parts and price list_CWT_update 051515.pub
AK 7/8/2015*

pn	name
03165	Bridle Rope Assembly
03403	Left Hand Wire Coil Door Assembly - C2
03404	Right Hand Wire Coil Door Assembly - C2
07143	Storage and Transport Chest C2
07558	Rear Wheel Strand Drive - J2/C2
15011	R.H. Pinion Shaft Assembly - C2
27670	Drive Housing Assembly - C2
27671	Rotating Drum Assembly - C2
27688	Front Plate Assembly - C2
27689	Rear Plate Assembly - C2
27697	L.H. Pinion Shaft Assembly - C2
33272	Bearing Retainer Kit - J2/C2
33274	Idler Gear and Shaft Kit - J2/C2
33356	Front Wheel Kit -J2/C2
33358	Gear Housing Bearing Kit - J2/C2
33359	Strand Wheel Kit - J2/C2
33361	Door Pulley Kit - J2/C2
33362	Snubbing Pulley Kit - J2/C2
33385	Gear Housing Cover Kit - C2
33387	Ratchet Kit - C2
33388	Tension Roller Kit - C2
33389	Small Ring Kit - C2
33390	Large Ring Kit - C2
33391	Ring Gear Kit - C2
33392	Spacer Kit - C2
33393	Roller Strand Kit - C2
33394	Front Plate Accessory Kit - C2
33395	Rear Bearing Kit - C2
33396	Front Bearing Kit - C2
33397	Front Lifter Assembly Complete - C2
33398	Mounting Kit - C2
33399	Tow Plate Kit - C2
33400	Hinge Bracket Kit - C2
33401	Rear Lifter Kit Complete - C2
33402	Rear Bracket Hinge -C2
33403	Shaft Kit - C2
33404	Vertical Roller Kit Complete - C2
33405	Roller Assembly - C2
33406	Mounting Kit - C2
33407	Door Accessory Kit - C2
33416	Handle Kit - C2
70190	Towing Lanyard 35' Long

Prices are subject to change without prior notice



C2 Cable Lasher Parts Identification Guide

Contact: GMP 3111 Old Lincoln Hwy Trevose, PA 19053 USA
 Tel: (215) 357-5500 Fax: (215) 357-6216
www.GMPtools.com

Note: Some Images may appear larger than they are for clarity purposes.

C2 parts and price list_CWT_update 051515.pub
 AK 7/8/2015

KIT COMPONENTS



ITEM# 27670
DRIVE HOUSING ASSEMBLY
USED IN: C2 DRIVE HOUSING
THIS KIT CONSISTS OF:
1 P/N 03171 DRIVE HOUSING
2 P/N 17866 INSERT



ITEM# 07558
REAR WHEEL STRAND DRIVE

USED IN: C2 DRIVE HOUSING
THIS KIT CONSISTS OF:
1 P/N 03013 RATCHET LASHER
1 P/N 03032 SHAFT 7/8 LASHER
1 P/N 03054 BEARING 88013
1 P/N 03318 PIN ROLL 156 1125
1 P/N 25011 GEAR BEVEL
1 P/N 25012 GEAR COMBINATION



ITEM# 33356
FRONT WHEEL KIT

USED IN: C2 DRIVE HOUSING
THIS KIT CONSIST OF:
1 P/N 03030 NUT
1 P/N 03277 RETAINING RING
1 P/N 07556 SHAFT ASSEMBLY



ITEM# 27697
L.H. PINION

USED IN: C2 DRIVE HOUSING
THIS KIT CONSISTS OF:
1 P/N 02015 GEAR SPUR
1 P/N 03003 LATCH LASHER
1 P/N 03004 COLLAR LASHER
1 P/N 03033 SHAFT LASHER
2 P/N 03276 RETAINING RING
1 P/N 03316 PIN ROLL 156 0875
1 P/N 17850 SSET 8-32X .18 SK
1 P/N 25010 GEAR PINION



ITEM# 15011
R.H. PINION

USED IN: C2 DRIVE HOUSING
THIS KIT CONSISTS OF:
1 P/N 02015 GEAR SPUR
1 P/N 03033 SHAFT LASHER
1 P/N 03036 COLLAR LASHER
1 P/N 03276 RETAINING RING
1 P/N 03288 SSET 8-32X .37 SK
1 P/N 03316 PIN ROLL 156 0875
1 P/N 25009 GEAR PINION BEVEL



ITEM# 33274
IDLER GEAR AND SHAFT KIT

USED IN: C2 DRIVE HOUSING
THIS KIT CONSISTS OF:
2 P/N 03056 BEARING OILITE
1 P/N 03309 PIN ROLL 094 0500
1 P/N 07565 SHAFT & GEAR
2 P/N 16692 WASHER .265 FLT



ITEM# 33358
GEAR HOUSING BEARING KIT

USED IN: C2 DRIVE HOUSING
THIS KIT CONSISTS OF:
2 p/n 03054 BEARING 88013
4 p/n 03055 BEARING 88500

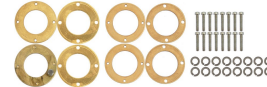

ITEM# 33272
BEARING RETAINING RNG KIT

USED IN: C2 DRIVE HOUSING
THIS KIT CONSISTS OF:
1 P/N 03022 COVER WASHER
2 P/N 03023 COVER WASHER
2 P/N 03024 COVER WASHER
2 P/N 03025 COVER WASHER
16 P/N 03260 WA 5 LOK ST ZN
16 P/N 03291 SMCH 5-40X .62
1 P/N 03328 PLATE STOP



ITEM# 33359
STRAND DRIVE WHEEL KIT

USED IN: C2 DRIVE HOUSING
THIS KIT CONSISTS OF:
2 p/n 03039 NT BLOCK SPEC
2 p/n 28115 STRAND DRIVE WHEEL
4 p/n 28116 WA CLAMPING

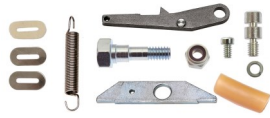

ITEM# 33387
RATCHET KIT

USED IN: C2 DRIVE HOUSING
THIS KIT CONSISTS OF:
2 p/n 03016 SPACER
1 p/n 03017 WIPER
1 p/n 03037 SPRING
1 p/n 03040 SCREW NECKED
1 p/n 03041 TUBE RUBBER
1 p/n 03263 WA 8 LOK ST ZN MD
1 p/n 17835 NT .250-20 HX ST
1 p/n 27686 LINK C2 LSHR
1 p/n 27826 SCREW ECCENTRIC
1 p/n 28247 LATCH/PIN ASSEMBLY
1 p/n 31306 SMCH 4-40X .18 FI



ITEM# 33385
GEAR HOUSING COVER KIT

USED IN: C2 DRIVE HOUSING
THIS KIT CONSISTS OF:
4 p/n 31315 SMCH 10-32X1.25 FI
1 p/n 27692 COVER

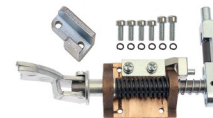

ITEM# 33388
TENSION ROLLER KIT

USED IN: C2 DRIVE HOUSING
THIS KIT CONSISTS OF:
6 p/n 03265 WA 10 LOK ST HI MD
1 p/n 27677 STOP STRAND ROLLER
1 p/n 27682 TENSION STRAND ASSY
2 p/n 31314 SMCH 10-24X .87 FI ST
4 p/n 31316 SMCH 10-32X .50 FI ST



ITEM# 33353
TAPERED PLUG KIT

USED IN: C2 DRIVE HOUSING
THIS KIT CONSISTS OF:
10 P/N 27494 TAPERED PLUG



ITEM# 27671
ROTATING DRUM ASSY

USED IN: C2 ROTATING DRUM
THIS KIT CONSISTS OF:
1 p/n 03287 SSET 8-32X .31
1 p/n 04739 BUSHING
1 p/n 07006 DRUM ROTATING



ITEM# 33362
SNUBBING PULLEY KIT

USED IN: C2 ROTATING DRUM
THIS KIT CONSISTS OF:
4 p/n 03288 SSET 8-32X .37
4 p/n 26055 PULLEY ASSY



ITEM# 33361
DOOR PULLEY KIT

USED IN: C2 DRIVE HOUSING
THIS KIT CONSISTS OF:
2 p/n 03064 TUBE LASHER
2 p/n 03257 PIN COTTER 125X .750
2 p/n 15067 PULLEY & BUSHING



C2 Cable Lasher Parts Identification Guide

Contact: GMP 3111 Old Lincoln Hwy Trevose, PA 19053 USA

Tel: (215) 357-5500 Fax: (215) 357-6216

www.GMPtools.com

Note: Some Images may appear larger than they are for clarity purposes.

C2 parts and price list_CWT_update 051515.pub
AK 7/8/2015

KIT COMPONENTS



ITEM# 33416
HANDLE KIT

USED IN: C2 DRIVE HOUSING
THIS KIT CONSISTS OF:
2 p/n 03269 SMCH 10-24X .75
1 p/n 04736 HANDLE

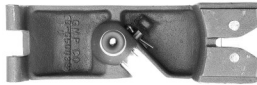

ITEM# 03404
R.H. DOOR ASSY

USED IN: C2 DRIVE HOUSING
THIS KIT CONSISTS OF:
1 p/n 02074 COIL DOOR
1 p/n 03064 TUBE LASHER
1 p/n 03065 PULLEY LASHER
2 p/n 03066 BEARING LOWER
1 p/n 03067 BUSHING
1 p/n 03068 PLATE LASHER
2 p/n 03069 WA .387
1 p/n 03257 PIN COTTER
2 p/n 16301 RVT .125X .625

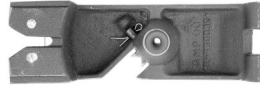

ITEM# 03403
L.H. DOOR ASSY

USED IN: C2 DRIVE HOUSING
THIS KIT CONSISTS OF:
1 p/n 03064 TUBE LASHER
1 p/n 03065 PULLEY LASHER
2 p/n 03066 BEARING LOWER
1 p/n 03067 BUSHING
1 p/n 03068 PLATE LASHER
2 p/n 03069 WA .387
1 p/n 03257 PIN COTTER
1 p/n 07007 COIL DOOR
2 p/n 16301 RVT .125X .625

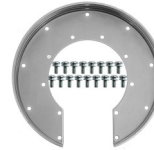

ITEM# 33389
SMALL RING KIT

USED IN: C2 DRIVE HOUSING
THIS KIT CONSISTS OF:
1 p/n 27673 RING BEARING SMALL
17 p/n 31309 SMCH 6-32X .31



ITEM# 33390
LARGE RING KIT

USED IN: C2 DRIVE HOUSING
THIS KIT CONSISTS OF:
1 p/n 27672 RING BEARING LARGE
11 p/n 31309 SMCH 6-32X .31

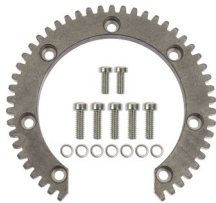

ITEM# 33391
RING GEAR KIT

USED IN: C2 DRIVE HOUSING
THIS KIT CONSISTS OF:
2 p/n 03303 SMCH 250-20X .50
5 p/n 03305 SMCH 250-20X .75
7 p/n 16005 WA .250 LOK
1 p/n 27674 RING GEAR



ITEM# 33407
DOOR ASSY KIT

USED IN: C2 DRIVE HOUSING
THIS KIT CONSISTS OF:
2 p/n 03067 BUSHING WIRE COIL
2 p/n 03068 PLATE LASHER
4 p/n 03325 WA .387 FLT ST
2 p/n 04734 PIN HINGE THUMB
2 p/n 04735 SPRING
2 p/n 04737 SPRING DOOR
2 p/n 04803 TUBE
2 p/n 07547 BOLT WING NUT
4 p/n 16301 RVT .125X .625



ITEM# 27688
FRONT PLATE ASSY

USED IN: C2 PLATES/SPACER
THIS KIT CONSISTS OF:
1 p/n 02020 BAR CATCH
2 p/n 02021 RING PULL
1 p/n 02022 CUP
1 p/n 03086 SLEEVE LASHER
1 p/n 03087 NT LOCKING BOLT RETAINER
1 p/n 03089 SPRING 11/32ID X 1 1/2 MUSIC
1 p/n 03090 BUSHING
8 p/n 03091 SCREW ECCENTRIC
4 p/n 03265 WA 10 LOK ST HI MD
8 p/n 03273 NT .250-28 HX ST
4 p/n 03298 SMCH 10-24X .62 FI ST S ZN
1 p/n 03311 PIN ROLL 59 028 125 0625
1 p/n 05918 SCAP 250-28X1.00 HX ST ZN
1 p/n 25144 BRACKET H LASHER
8 p/n 26051 BEARING
16 p/n 26052 SPACER BEARING
1 p/n 27675 PLATE FRONT
6 p/n 28033 SCAP 250-20X.62 SK ST A BO



ITEM# 33394
FRONT PLATE ACCESSORY KIT

USED IN: C2 PLATES/SPACER
THIS KIT CONSISTS OF:
1 p/n 02020 BAR CATCH
2 p/n 02021 RING PULL
1 p/n 02022 CUP
1 p/n 02068 SPRING COMPRESSION
1 p/n 03089 SPRING 11/32ID X 1 1/2
4 p/n 03265 WA 10 LOK ST HI MD
2 p/n 03273 NT .250-28 HX
4 p/n 03298 SMCH 10-24X .62 FI
1 p/n 03311 PIN ROLL 59 028 125 0625
1 p/n 15452 BOLT LOCKING ASSY
1 p/n 15038 HOUSING LOCKPIN
2 p/n 16013 SCAP 250-28X1.00 HX
1 p/n 25144 BRACKET H LASHER



ITEM# 33396
FRONT BEARING KIT

USED IN: C2 PLATES/SPACER
THIS KIT CONSISTS OF:
8 p/n 03091 SCREW ECCENTRIC
8 p/n 03273 NT .250-28 HX ST
8 p/n 26051 BEARING RAD 608
16 p/n 26052 SPACER BEARING



ITEM# 33393
ROLLER STRAND KIT

USED IN: C2 PLATES/SPACER
THIS KIT CONSISTS OF:
1 p/n 02026 PIN 3/16
1 p/n 02029 HOLDER
2 p/n 03370 SSET 10-32X .25
1 p/n 25145 ROLLER STRAND
2 p/n 31324 SMCH 10-32X .62



ITEM# 33392
SPACER KIT

USED IN: C2 PLATES/SPACER
THIS KIT CONSISTS OF:
1 p/n 27676 SPACER C2 LASHER
12 p/n 28033 SCAP 250-20X .62



C2 Cable Lasher Parts Identification Guide

Contact: GMP 3111 Old Lincoln Hwy Trevose, PA 19053 USA

Tel: (215) 357-5500 Fax: (215) 357-6216

www.GMPtools.com

Note: Some Images may appear larger than they are for clarity purposes.

C2 parts and price list_CWT_update 051515.pub
AK 7/8/2015

KIT COMPONENTS



ITEM# 27689
REAR PLATE ASSEMBLY

USED IN: C2 PLATES/SPACER
THIS KIT CONSISTS OF:
6 p/n 03091 SCREW ECCENTRIC
6 p/n 03273 NT .250-28 HX
4 p/n 25158 SCREW SPEC
10 p/n 26051 BEARING RAD608D
20 p/n 26052 SPACER BEARING
1 p/n 27685 PLATE REAR
6 p/n 28033 SCAP 250-20X.62 SK



ITEM# 33395
REAR BEARING KIT

USED IN: C2 PLATES/SPACER
THIS KIT CONSISTS OF:
6 p/n 03091 SCREW ECCENTRIC
6 p/n 03273 NT .250-28 HX ST
4 p/n 25158 SCREW SPEC
10 p/n 26051 BEARING RAD608D
20 p/n 26052 SPACER BEARING

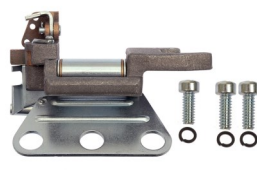

ITEM# 33397
FRONT LIFTER ASSEMBLY

USED IN: FRONT LIFTER
THIS KIT CONSISTS OF:
3 p/n 03265 WA 10 LOK ST HI
1 p/n 27691 GATE FRONT ASSY
2 p/n 31312 SMCH 10-24X .62
1 p/n 31316 SMCH 10-32X .50



ITEM# 33399
TOW PLATE KIT

USED IN: FRONT LIFTER
THIS KIT CONSISTS OF:
1 p/n 02032 SHAFT 1/4
1 p/n 07204 PLATE PULLING
1 p/n 27843 SPRG TORSION



ITEM# 33398
MOUNTING KIT

USED IN: FRONT LIFTER
THIS KIT CONSISTS OF:
1 p/n 02033 LOCK H LASHER
1 p/n 02036 SPRING COMP
1 p/n 02037 PIN ROLL 187 0500
1 p/n 02038 SC SHOULDER
1 p/n 02039 PIN 3/16
1 p/n 02040 LATCH
1 p/n 02077 STOP

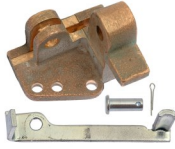

ITEM# 333400
HINGE BRACKET KIT

USED IN: FRONT LIFTER
THIS KIT CONSISTS OF:
1 p/n 02067 PIN 1/4
1 p/n 02070 BRACKET
1 p/n 03255 PIN COTTER
1 p/n 27678 LEVER

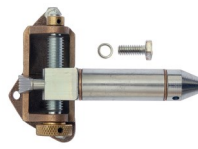

ITEM# 33401
REAR LIFTER KIT COMPLETE

USED IN: REAR LIFTER
THIS KIT CONSISTS OF:
1 p/n 03408 LIFTER REAR
1 p/n 16005 WA .250 LOK
1 p/n 28090 SCAP 250-20X .875

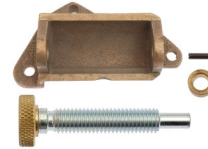

ITEM# 33402
REAR BRACKET HINGE

USED IN: REAR LIFTER
THIS KIT CONSISTS OF:
1 p/n 02044 BUSHING
1 p/n 03373 PIN ROLL 125 500
1 p/n 15005 NOB & SHAFT
1 p/n 27818 HINGE REAR

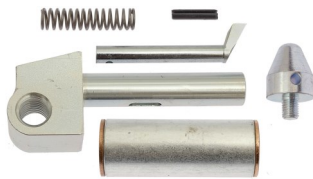

ITEM# 33403
SHAFT KIT

USED IN: REAR LIFTER
THIS KIT CONSISTS OF:
1 p/n 02047 NOSE
1 p/n 02050 SPRING
1 p/n 02051 SHAFT
1 p/n 02052 CLUB C LASHER
1 p/n 15451 ROLLER ASSY
1 p/n 17599 PIN ROLL 125 0437



ITEM# 33404
VERTICAL ROLLER KIT

USED IN: VERTICAL GUIDE
THIS KIT CONSISTS OF:
1 p/n 03265 WA 10 LOK
2 p/n 16213 SCAP 10-24X .62
1 p/n 27698 ROLLER VERT
1 p/n 28032 SPACER VERT



ITEM# 33405
ROLLER ASSY.

USED IN: VERTICAL GUIDE
THIS KIT CONSISTS OF:
1 p/n 02055 NT GUIDE
1 p/n 02056 NT GUIDE
2 p/n 02061 STUD
2 p/n 07509 ROLLER

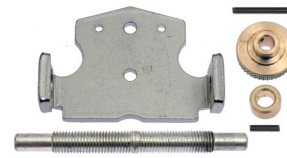

ITEM# 33406
MOUNTING KIT

USED IN: VERTICAL GUIDE
THIS KIT CONSISTS OF:
1 p/n 02054 SHAFT 5/16-24
1 p/n 02057 KNOB KNURL
1 p/n 02058 COLLAR
1 p/n 09131 PIN ROLL125 1000
1 p/n 17599 PIN ROLL125 0437
1 p/n 27684 STAMPING



C2 Cable Lasher Parts Identification Guide

Contact: GMP 3111 Old Lincoln Hwy Trevose, PA 19053 USA

Tel: (215) 357-5500 Fax: (215) 357-6216

www.GMPtools.com

Note: Some Images may appear larger than they are for clarity purposes.

C2 parts and price list_CWT_update 051515.pub
AK 7/8/2015

